

QUARTER HORSE SHOW OF THE YEAR

04 t/m 07 November 2010
New Azelhof – 2500 Lier – Belgium

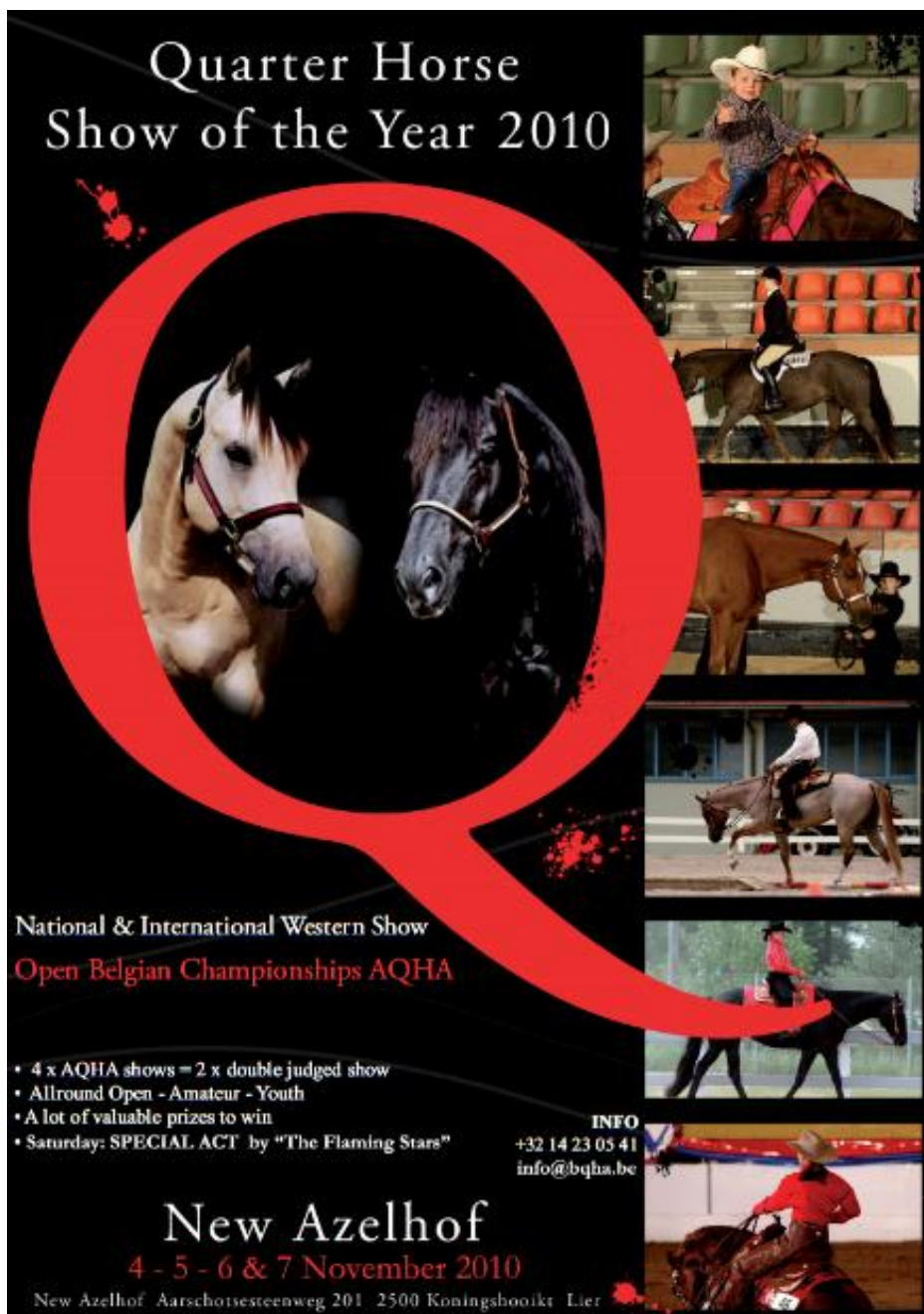

Quarter Horse
Show of the Year 2010

National & International Western Show
Open Belgian Championships AQHA

- 4 x AQHA shows = 2 x double judged show
- Allround Open - Amateur - Youth
- A lot of valuable prizes to win
- Saturday: SPECIAL ACT by "The Flaming Stars"

INFO
+32 14 23 05 41
info@bqha.be

New Azelhof
4 - 5 - 6 & 7 November 2010
New Azelhof Aarschotsesteenweg 201 2500 Koningshooikt Lier

Patterns Show A



"QUARTER HORSE SHOW OF THE YEAR"

Show A: 04 & 05 November 2010 - Show B: 06 & 07 November 2010
New Azelhof – Aarschotsesteenweg 201 – 2500 Lier – Belgium

Patterns Show A

Hunt Seat Equitation

(Beginners Youth/Beginners Amateur)

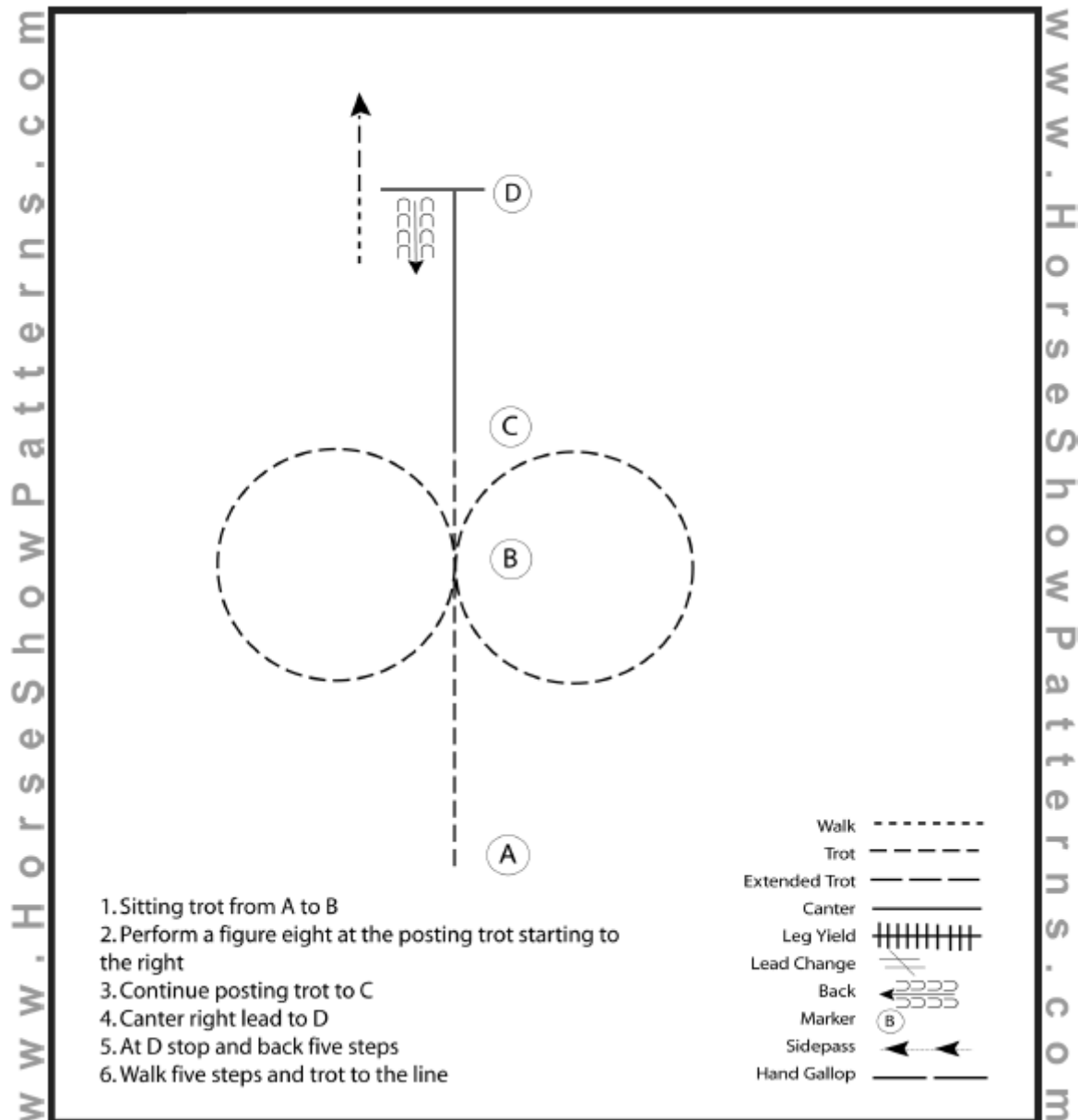

Judges: Sylvia Jaeckle (Germany), Leo W. Fourre (USA)



"QUARTER HORSE SHOW OF THE YEAR"

Show A: 04 & 05 November 2010 - Show B: 06 & 07 November 2010
New Azelhof – Aarschotsesteenweg 201 – 2500 Lier – Belgium

Patterns Show A

Hunt Seat Equitation

(Novice Amateur/Novice Youth)

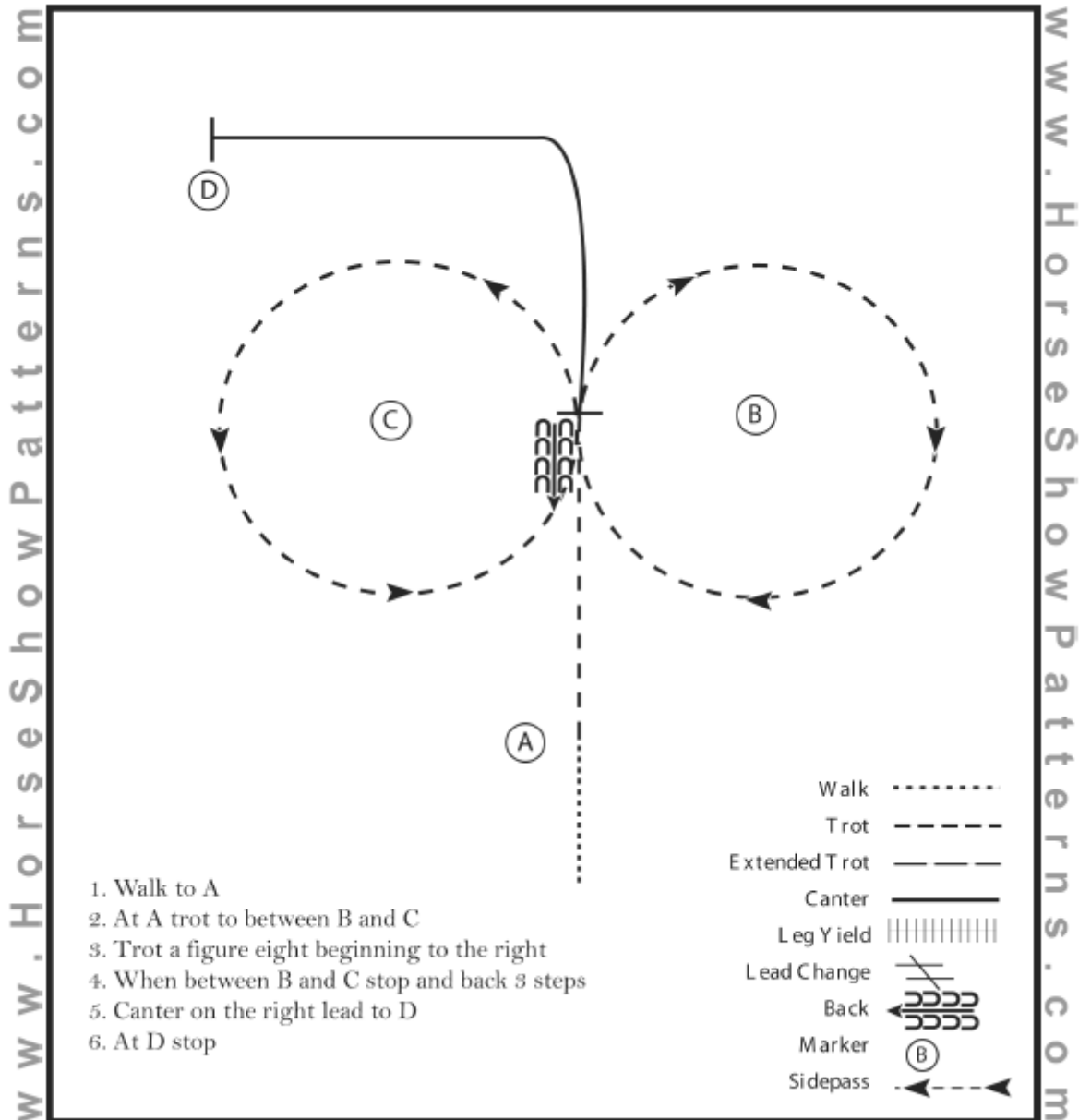

Judges: Sylvia Jaeckle (Germany), Leo W. Fourre (USA)



"QUARTER HORSE SHOW OF THE YEAR"

Show A: 04 & 05 November 2010 - Show B: 06 & 07 November 2010
New Azelhof – Aarschotsesteenweg 201 – 2500 Lier – Belgium

Patterns Show A

Hunt Seat Equitation (Amateur/Youth)

www.HorseShowPatterns.com

www.HorseShowPatterns.com

1. Canter on the right lead A to B
2. At B posting trot around B
3. At B canter on the left lead to and around C and continue towards A
4. Halfway to A posting trot on the right diagonal to and around A and continue towards C
5. Halfway to C sit the trot
6. Stop at C

Walk
Trot	-----
Extended Trot	-----
Canter	—————
Leg Yield	
Lead Change	↗↘
Back	←←←←
Marker	⊙
Sidepass	→→→→

Judges: Sylvia Jaeckle (Germany), Leo W. Fourre (USA)



"QUARTER HORSE SHOW OF THE YEAR"

Show A: 04 & 05 November 2010 - Show B: 06 & 07 November 2010
New Azelhof – Aarschotsesteenweg 201 – 2500 Lier – Belgium

Patterns Show A

Showmanship at Halter

(Novice Amateur/Novice Youth)

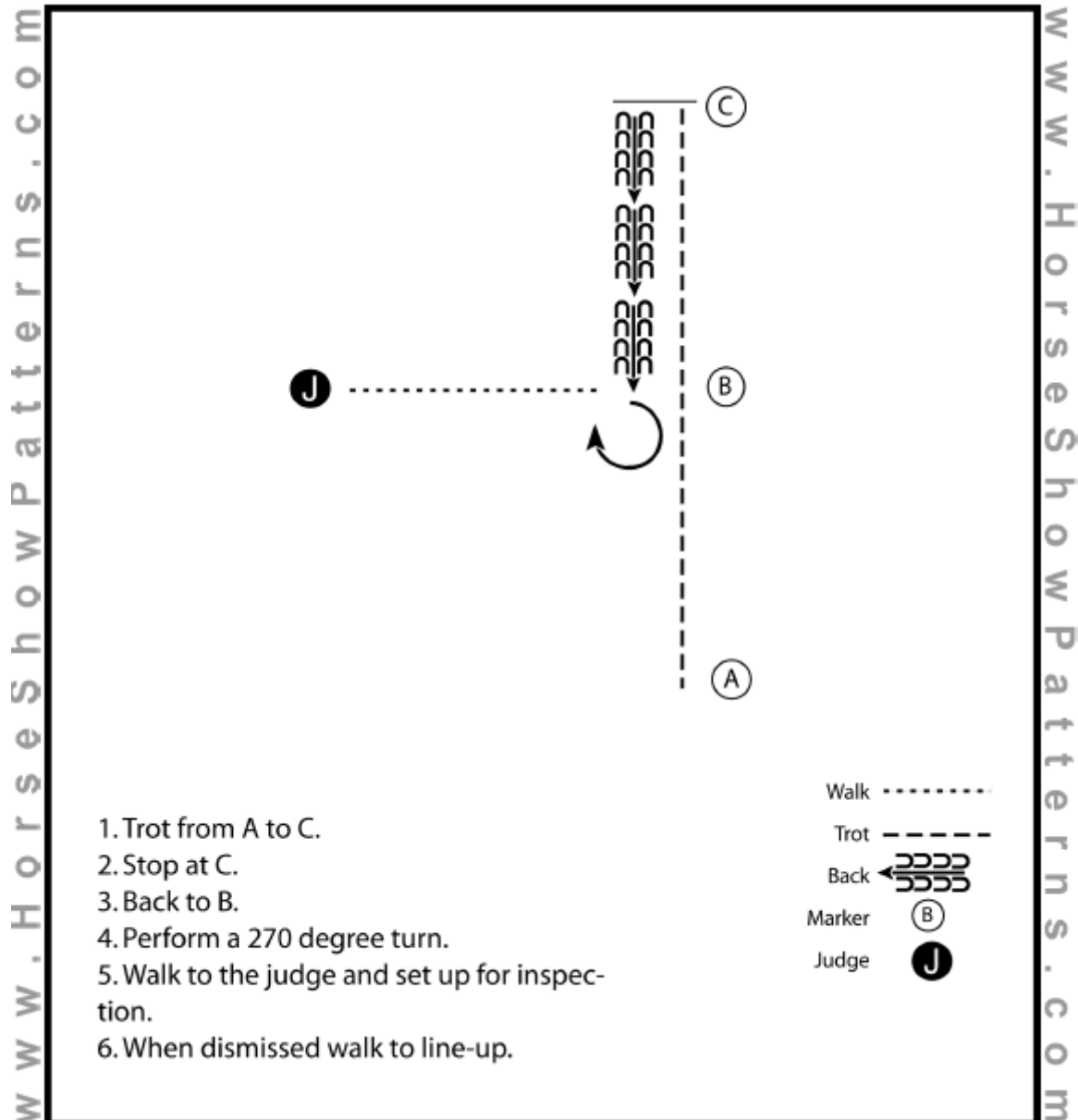

Judges: Sylvia Jaeckle (Germany), Leo W. Fourre (USA)



"QUARTER HORSE SHOW OF THE YEAR"

Show A: 04 & 05 November 2010 - Show B: 06 & 07 November 2010
New Azelhof – Aarschotsesteenweg 201 – 2500 Lier – Belgium

Patterns Show A

Showmanship at Halter (Amateur/Youth)

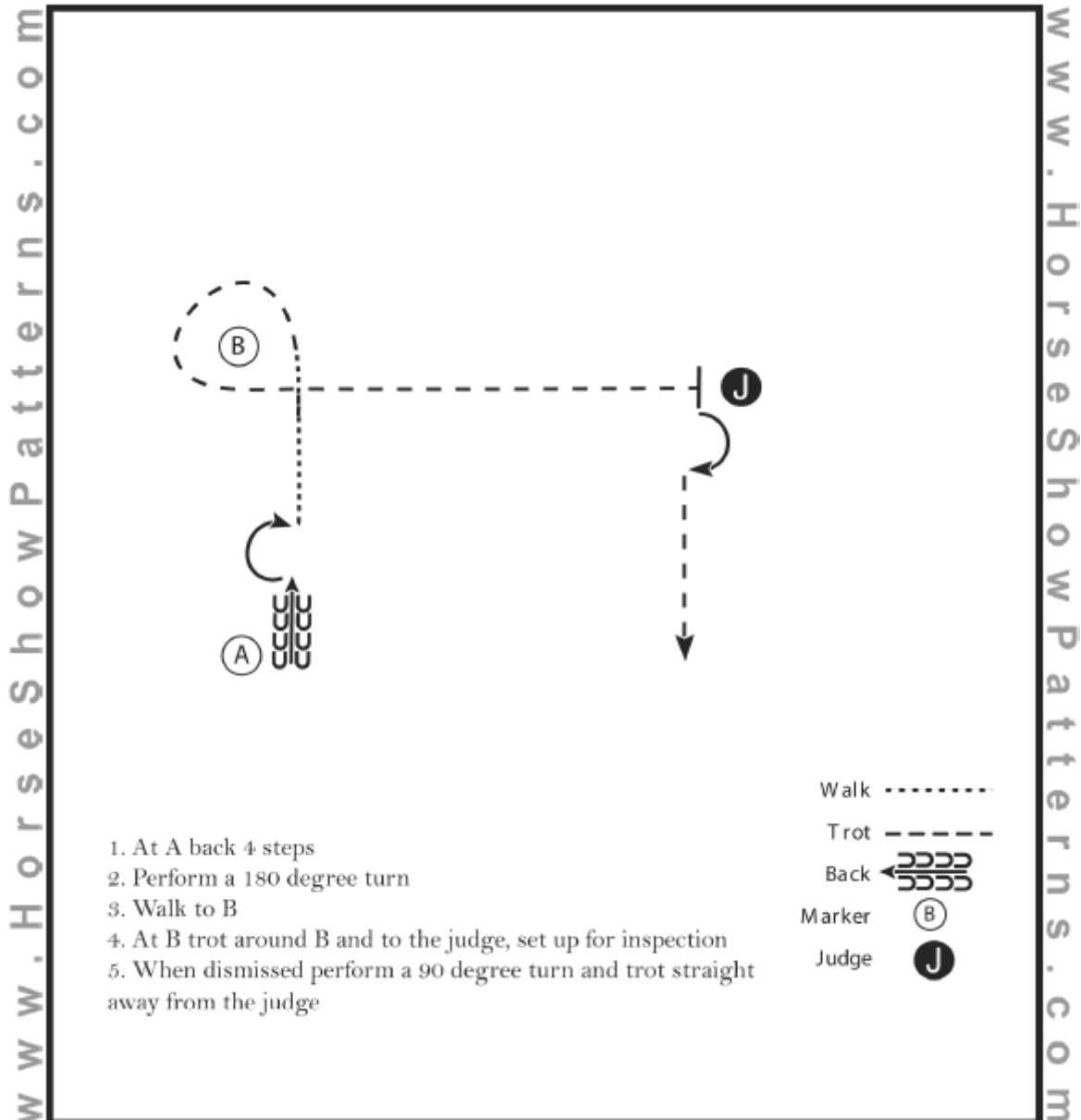

Judges: Sylvia Jaeckle (Germany), Leo W. Fourre (USA)



"QUARTER HORSE SHOW OF THE YEAR"

Show A: 04 & 05 November 2010 - Show B: 06 & 07 November 2010
New Azelhof – Aarschotsesteenweg 201 – 2500 Lier – Belgium

Patterns Show A

Western Horsemanship

(Novice Amateur/Novice Youth/Amateur Select)

www.HorseShowPatterns.com

www.HorseShowPatterns.com

1. Jog A to B.
2. Stop at B and perform a 180 degree turn to the right on the hindquarters.
3. Jog a circle to the left.
4. At B lope a circle to the right on the right lead.
5. Stop at B and perform a 180 degree turn to the left.
6. Jog B to C.
7. Stop at C.

Walk
Jog	- - - - -
Extended Jog	—————
Lope	—————
Leg Yield	
Lead Change	↖ ↗
Back	←←←←←
Marker	⊙
Sidepass	←———

Judges: Sylvia Jaeckle (Germany), Leo W. Fourre (USA)



"QUARTER HORSE SHOW OF THE YEAR"

Show A: 04 & 05 November 2010 - Show B: 06 & 07 November 2010
New Azelhof – Aarschotsesteenweg 201 – 2500 Lier – Belgium

Patterns Show A

Western Horsemanship (Amateur/Youth)

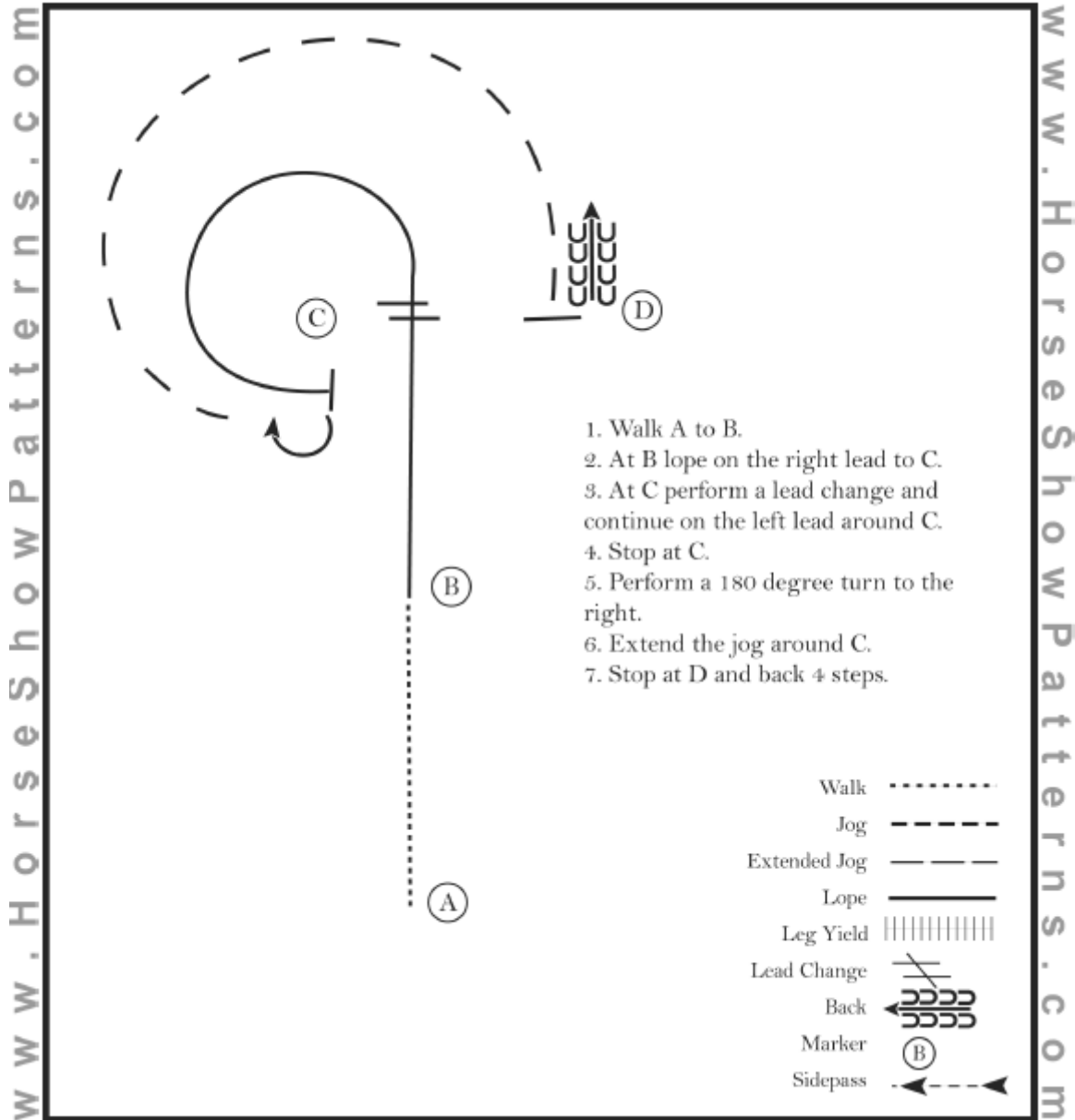

Judges: Sylvia Jaeckle (Germany), Leo W. Fourre (USA)



"QUARTER HORSE SHOW OF THE YEAR"

Show A: 04 & 05 November 2010 - Show B: 06 & 07 November 2010
 New Azelhof – Aarschotsesteenweg 201 – 2500 Lier – Belgium

Patterns Show A

Trail

(Green/Novice Amateur/Novice Youth)

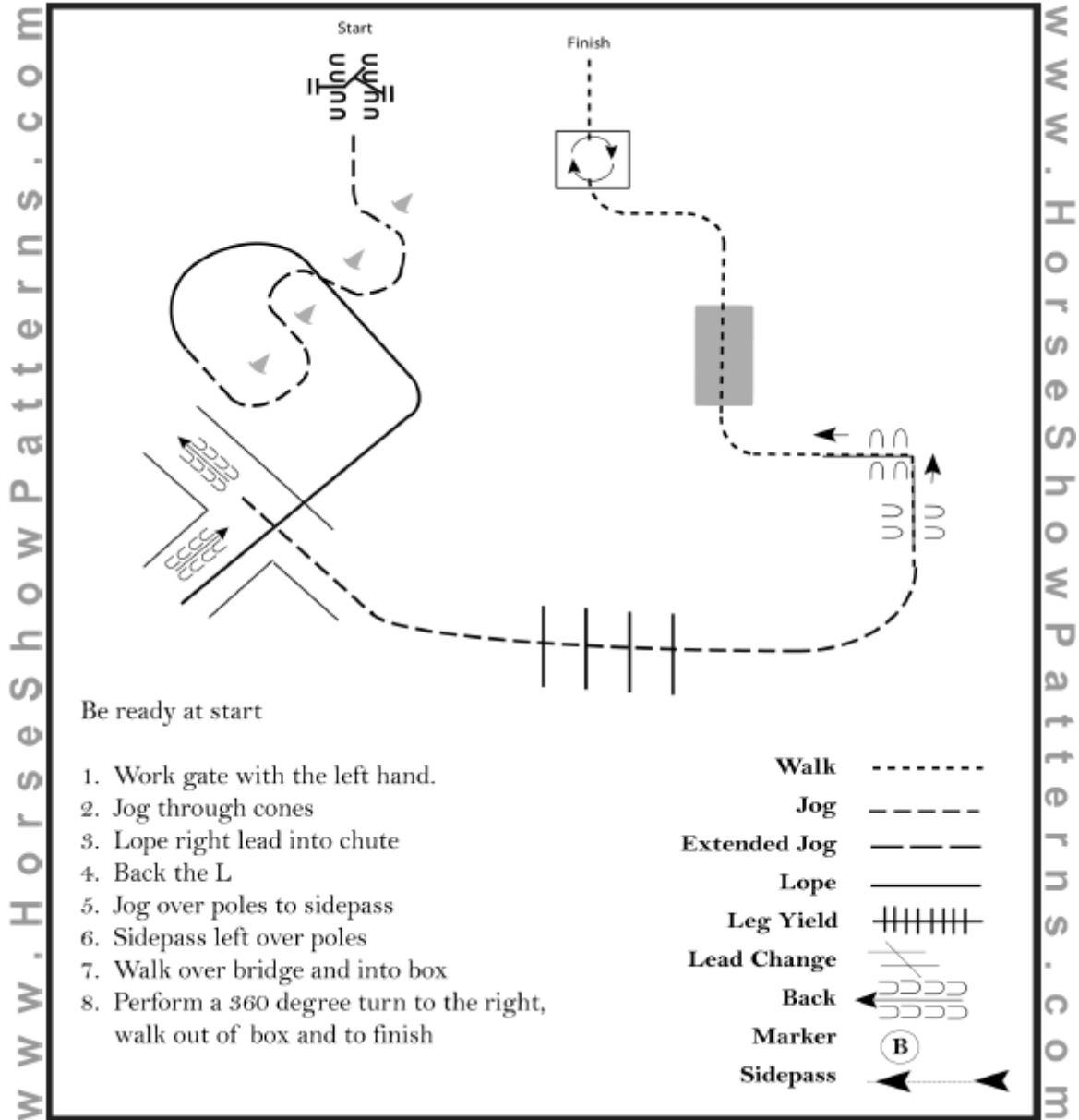

Judges: Sylvia Jaeckle (Germany), Leo W. Fourre (USA)



"QUARTER HORSE SHOW OF THE YEAR"

Show A: 04 & 05 November 2010 - Show B: 06 & 07 November 2010
 New Azelhof – Aarschotsesteenweg 201 – 2500 Lier – Belgium

Patterns Show A

Trail

(Amateur/Youth)

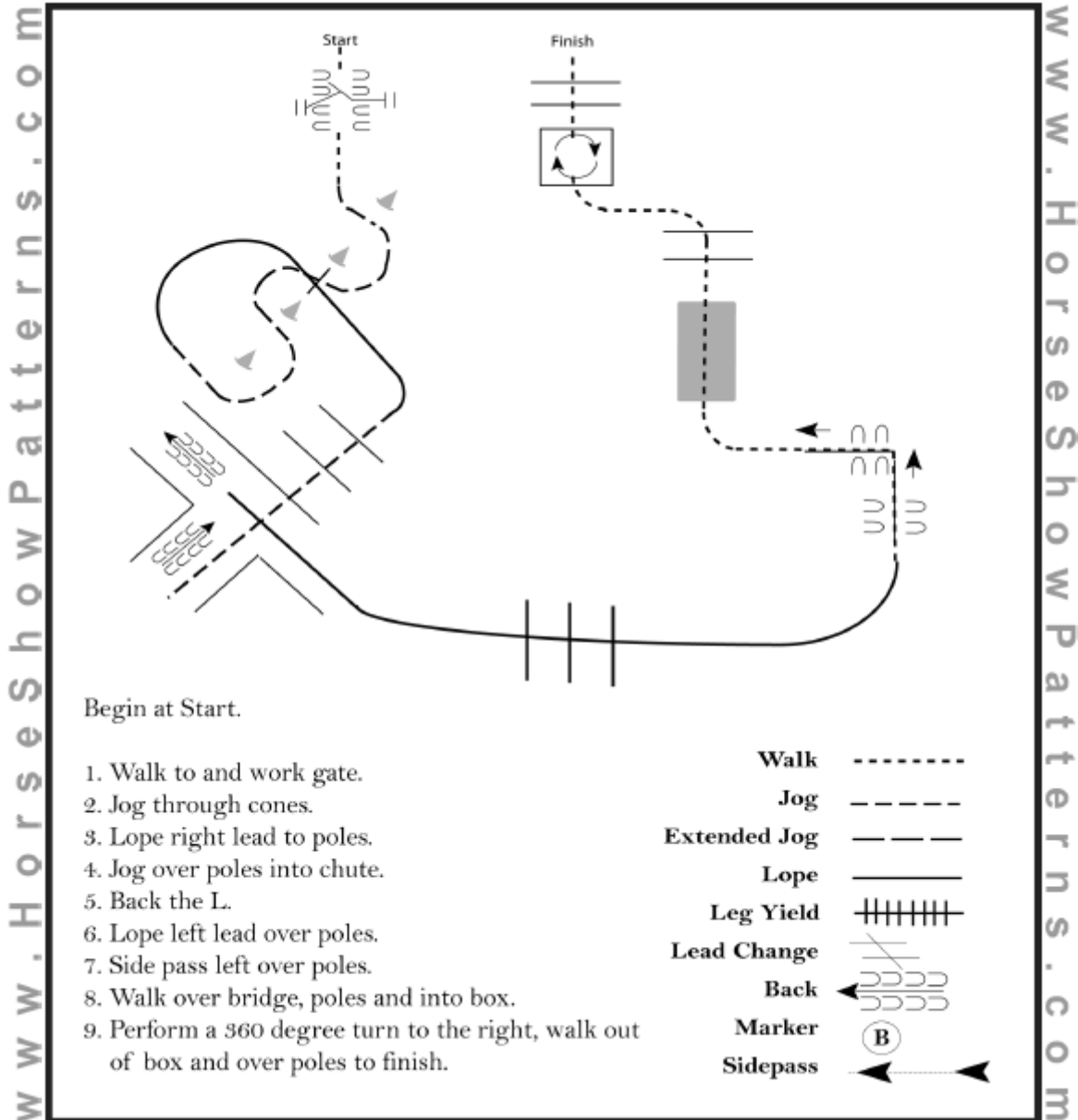

Judges: Sylvia Jaeckle (Germany), Leo W. Fourre (USA)



"QUARTER HORSE SHOW OF THE YEAR"

Show A: 04 & 05 November 2010 - Show B: 06 & 07 November 2010
 New Azelhof – Aarschotsesteenweg 201 – 2500 Lier – Belgium

Patterns Show A

Trail

(Open All Ages)

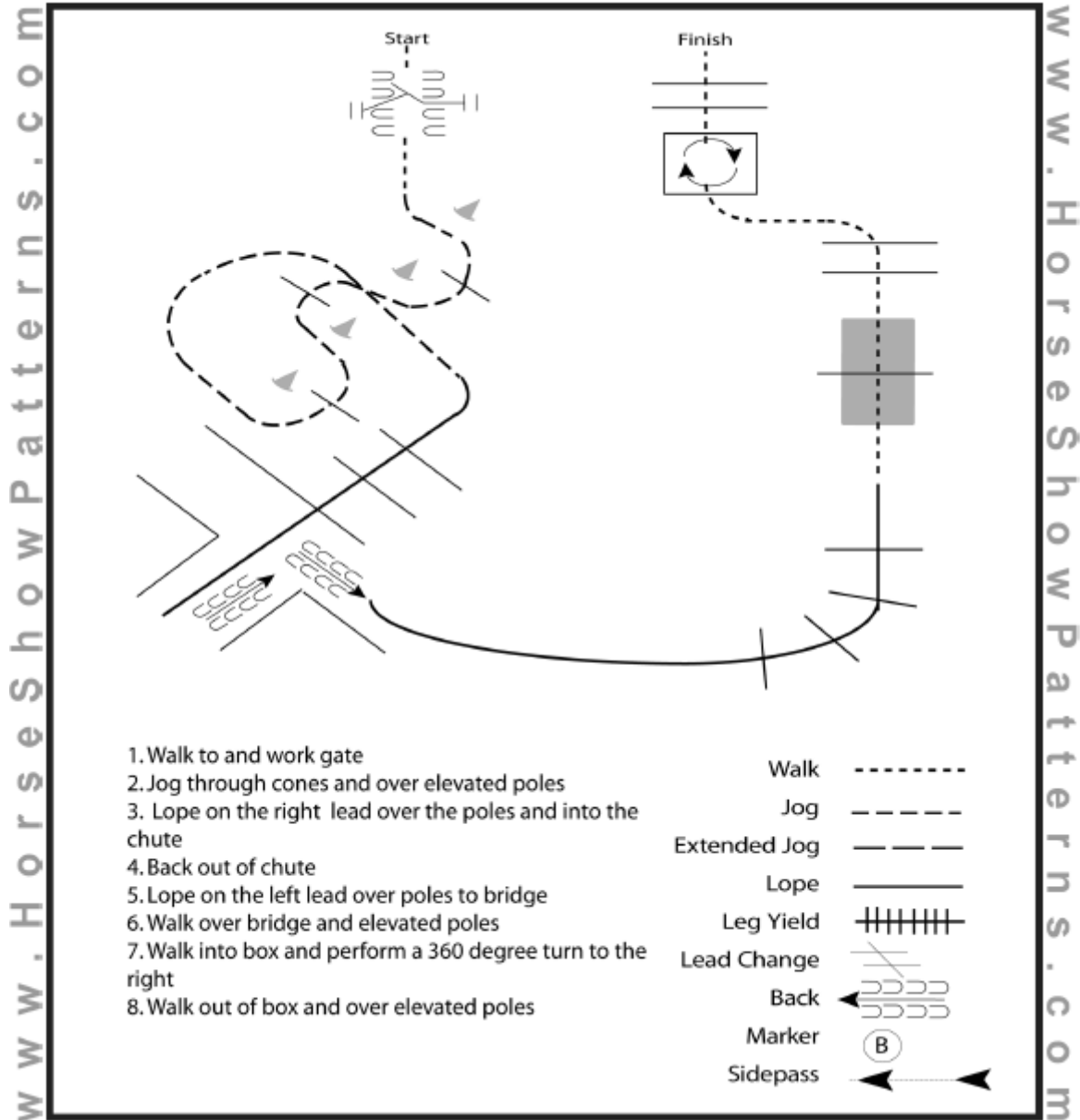

Judges: Sylvia Jaeckle (Germany), Leo W. Fourre (USA)



"QUARTER HORSE SHOW OF THE YEAR"

Show A: 04 & 05 November 2010 - Show B: 06 & 07 November 2010
New Azelhof – Aarschotsesteenweg 201 – 2500 Lier – Belgium

Patterns Show A

Reining (Pattern number 8)

(Beginners Amateur/ Green Horses All Riders, All Breeds)

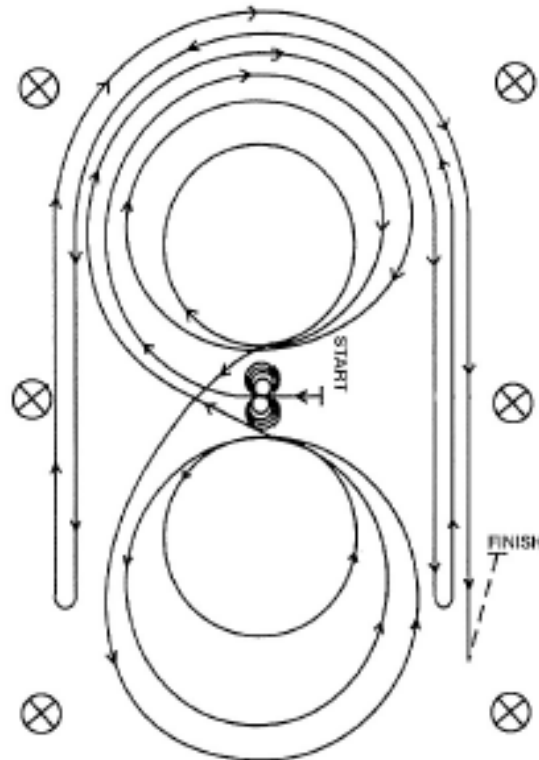

Horse must walk or stop prior to starting pattern.

Beginning at the center of the arena facing the left wall or fence.

1. Complete four spins to the left.
2. Complete four spins to the right. Hesitate.
3. Beginning on the right lead, complete three circles to the right: the first circle large and fast; the second circle small and slow; the third circle large and fast. Change leads at the center of the arena.
4. Complete three circles to the left: the first circle large and fast; the second circle small and slow; the third circle large and fast. Change leads at the center of the arena.
5. Begin a large fast circle to the right but do not close this circle. Run straight down the right side of the arena past the center marker and do a left rollback at least 20 feet (6 meters) from the wall or fence - no hesitation.
6. Continue back around the previous circle but do not close this circle. Run down the left side of the arena past the center marker and do a right rollback at least 20 feet (6 meters) from the wall or fence - no hesitation.
7. Continue back around the previous circle but do not close this circle. Run down the right side of the arena past the center marker and do a sliding stop at least 20 feet (6 meters) from the wall or fence. Back up at least 10 feet. Hesitate to demonstrate completion of the pattern.

Rider may drop bridle to the designated judge.

Judges: Sylvia Jaeckle (Germany), Leo W. Fourre (USA)



"QUARTER HORSE SHOW OF THE YEAR"

Show A: 04 & 05 November 2010 - Show B: 06 & 07 November 2010
New Azelhof – Aarschotsesteenweg 201 – 2500 Lier – Belgium

Patterns Show A

Reining (Pattern number 6) (Novice Amateur/ Novice Youth)

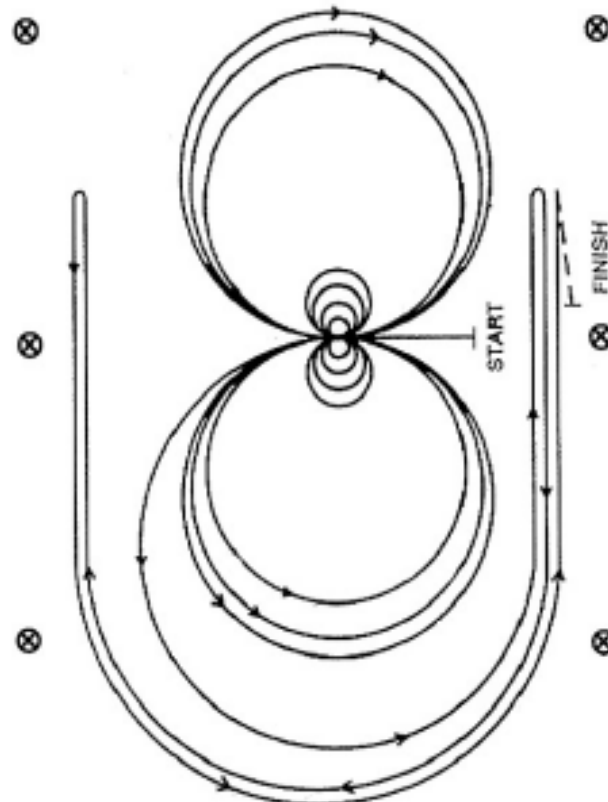

Horse must walk or stop prior to starting pattern.

Beginning at the center of the arena facing the left wall or fence.

1. Complete four spins to the right.
2. Complete four spins to the left. Hesitate.
3. Beginning on the left lead, complete three circles to the left: the first two circles large and fast; the third circle small and slow. Change leads at the center of the arena.
4. Complete three circles to the right: the first two circles large and fast; the third circle small and slow. Change leads at the center of the arena.
5. Begin a large fast circle to the left but do not close this circle. Run up the right side of the arena past the center marker and do a right roll-back at least 20 feet (6 meters) from the wall or fence - no hesitation.
6. Continue back around previous circle but do not close this circle. Run up the left side of the arena past the center marker and do a left roll-back at least 20 feet (6 meters) from the wall or fence - no hesitation.
7. Continue back around previous circle but do not close this circle. Run up the right side of the arena past the center marker and do a sliding stop at least 20 feet (6 meters) from the wall or fence. Back up at least 10 feet (3 meters). Hesitate to demonstrate the completion of the pattern.

Rider may drop bridle to the designated judge.

Judges: Sylvia Jaeckle (Germany), Leo W. Fourre (USA)



"QUARTER HORSE SHOW OF THE YEAR"

Show A: 04 & 05 November 2010 - Show B: 06 & 07 November 2010
New Azelhof – Aarschotsesteenweg 201 – 2500 Lier – Belgium

Patterns Show A

Reining (Pattern number 5) (Youth)

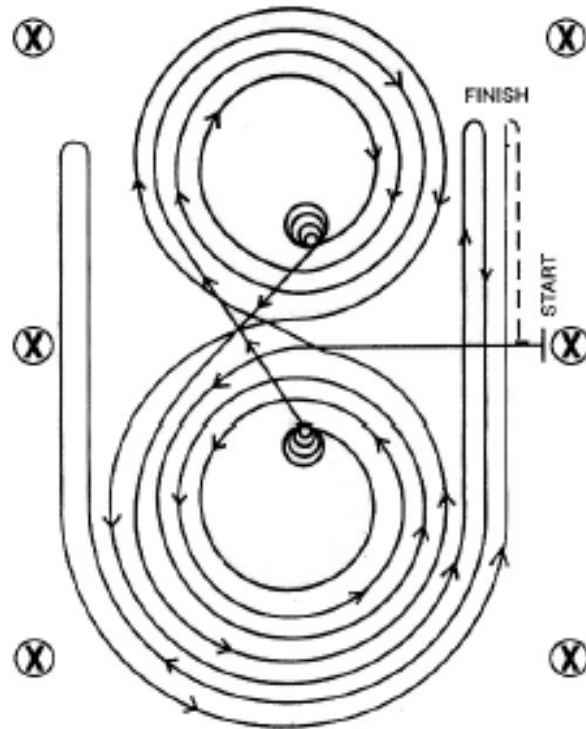

Horse must walk or stop prior to starting pattern.

Beginning at the center of the arena facing the left wall or fence.

1. Beginning on the left lead, complete three circles to the left: the first two circles large and fast; the third circle small and slow. Stop at the center of the arena.
2. Complete four spins to the left. Hesitate.
3. Beginning on the right lead, complete three circles to the right: the first two circles large and fast; the third circle small and slow. Stop at the center of the arena.
4. Complete four spins to the right. Hesitate.
5. Beginning on the left lead, run a large fast circle to the left, change leads at the center of the arena, run a large fast circle to the right, and change leads at the center of the arena. (Figure 8)
6. Continue around previous circle to the left but do not close this circle. Run up the right side of the arena past the center marker and do a right rollback at least 20 feet (6 meters) from the wall or fence - no hesitation.
7. Continue around previous circle but do not close this circle. Run up the left side of the arena past the center marker and do a left rollback at least 20 feet (6 meters) from the wall or fence - no hesitation.
8. Continue back around previous circle but do not close this circle. Run up the right side of the arena past the center marker and do a sliding stop at least 20 feet (6 meters) from the wall or fence. Back up at least 10 feet (3 meters). Hesitate to demonstrate completion of the pattern.

Rider may drop bridle to the designated judge.

Judges: Sylvia Jaeckle (Germany), Leo W. Fourre (USA)



"QUARTER HORSE SHOW OF THE YEAR"

Show A: 04 & 05 November 2010 - Show B: 06 & 07 November 2010
New Azelhof – Aarschotsesteenweg 201 – 2500 Lier – Belgium

Patterns Show A

Reining (Pattern number 9)

(Amateur / Amateur Select)

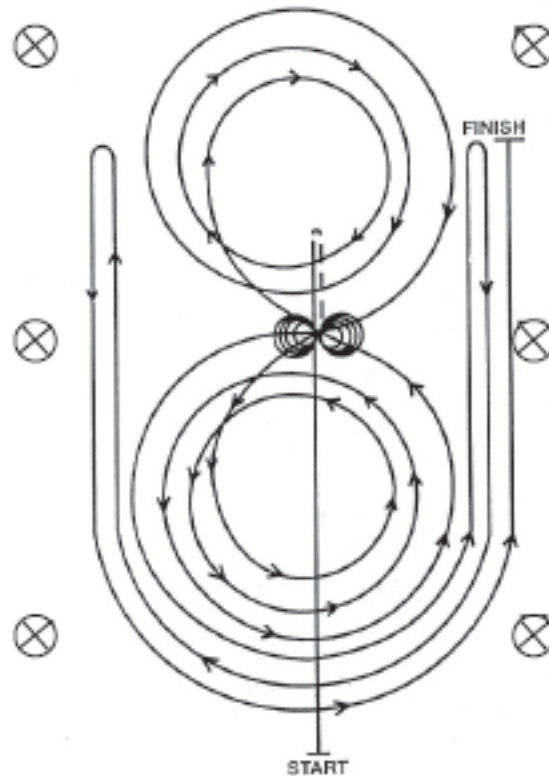

1. Run past the center marker and do a sliding stop. Back up to the center of the arena or at least 10 feet (3 meters). Hesitate.
2. Complete four spins to the right.
3. Complete four and one-quarter spins to the left so that horse is facing the left wall or fence. Hesitate.
4. Beginning on the left lead, complete three circles to the left: the first circle small and slow; the next two circles large and fast. Change leads at the center of the arena.
5. Complete three circles to the right: the first circle small and slow; the next two circles large and fast. Change leads at the center of the arena.
6. Begin a large fast circle to the left but do not close this circle. Run up the right side of the arena past the center marker and do a right rollback at least 20 feet (6 meters) from the wall or fence - no hesitation.
7. Continue back around the previous circle but do not close this circle. Run up the left side of the arena past the center marker and do a left rollback at least 20 feet (6 meters) from the wall or fence - no hesitation.
8. Continue back around previous circle but do not close this circle. Run up right side of the arena past the center marker and do a sliding stop at least 20 feet (6 meters) from the wall or fence. Hesitate to demonstrate completion of the pattern.

Rider may drop bridle to the designated judge.

Judges: Sylvia Jaeckle (Germany), Leo W. Fourre (USA)



"QUARTER HORSE SHOW OF THE YEAR"

Show A: 04 & 05 November 2010 - Show B: 06 & 07 November 2010
New Azelhof – Aarschotsesteenweg 201 – 2500 Lier – Belgium

Patterns Show A

Reining (Pattern number 8)

(Junior Open)

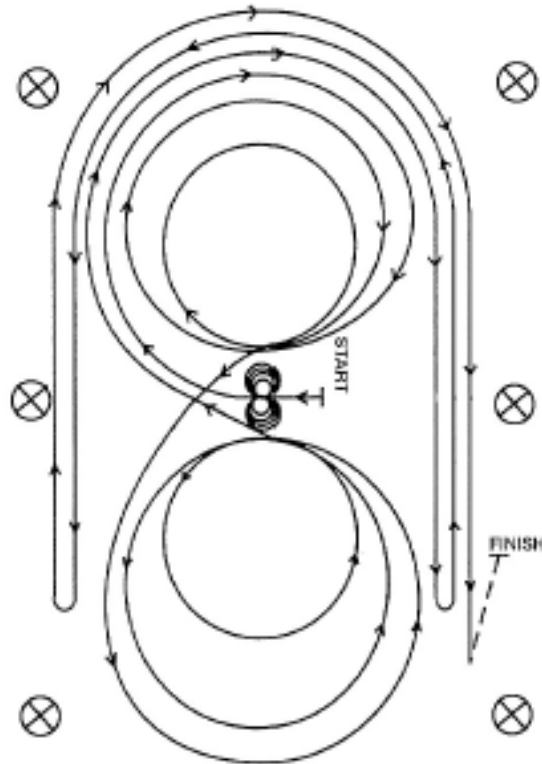

Horse must walk or stop prior to starting pattern.

Beginning at the center of the arena facing the left wall or fence.

1. Complete four spins to the left.
2. Complete four spins to the right. Hesitate.
3. Beginning on the right lead, complete three circles to the right: the first circle large and fast; the second circle small and slow; the third circle large and fast. Change leads at the center of the arena.
4. Complete three circles to the left: the first circle large and fast; the second circle small and slow; the third circle large and fast. Change leads at the center of the arena.
5. Begin a large fast circle to the right but do not close this circle. Run straight down the right side of the arena past the center marker and do a left rollback at least 20 feet (6 meters) from the wall or fence - no hesitation.
6. Continue back around the previous circle but do not close this circle. Run down the left side of the arena past the center marker and do a right rollback at least 20 feet (6 meters) from the wall or fence - no hesitation.
7. Continue back around the previous circle but do not close this circle. Run down the right side of the arena past the center marker and do a sliding stop at least 20 feet (6 meters) from the wall or fence. Back up at least 10 feet. Hesitate to demonstrate completion of the pattern.

Rider may drop bridle to the designated judge.

Judges: Sylvia Jaeckle (Germany), Leo W. Fourre (USA)



"QUARTER HORSE SHOW OF THE YEAR"

Show A: 04 & 05 November 2010 - Show B: 06 & 07 November 2010
New Azelhof – Aarschotsesteenweg 201 – 2500 Lier – Belgium

Patterns Show A

Reining (Pattern number 10)

(Senior Open)

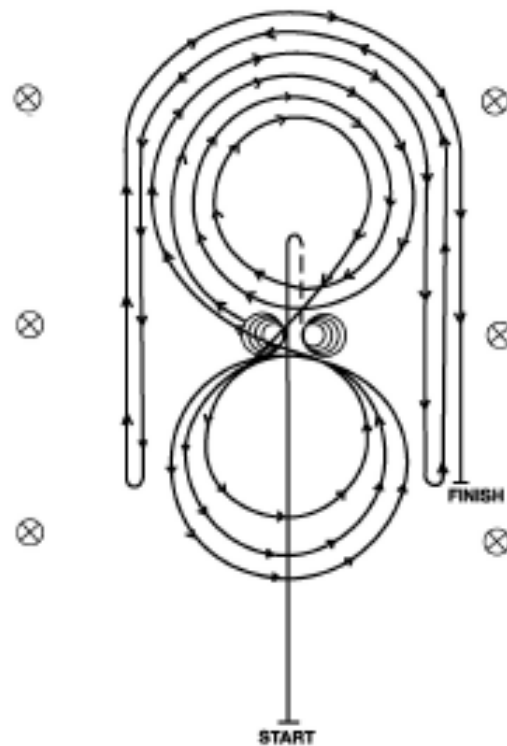

⊗ MARKER

1. Run past the center marker and do a sliding stop. Back up to the center of the arena or at least 10 feet (3 meters). Hesitate.
2. Complete four spins to the right.
3. Complete four and one-quarter spins to the left so that the horse is facing the left wall or fence. Hesitate.
4. Beginning on the right lead, complete three circles to the right: the first two circles large and fast, the third circle small and slow. Change leads at the center of the arena.
5. Complete three circles to the left: the first circle small and slow, the next two circles large and fast. Change leads at the center of the arena.
6. Begin a large fast circle to the right but do not close this circle. Run down the right side of the arena past the marker and do a left rollback at least 20 feet (6 meters) from the wall or fence - no hesitation.
7. Continue back around the previous circle but do not close this circle. Run down the left side of the arena past the center and do a right rollback at least 20 feet (6 meters) from the wall or fence - no hesitation.
8. Continue back around previous circle but do not close this circle. Run down the right side of the arena past the center marker and do a sliding stop at least 20 feet (6 meters) from the wall or fence. Hesitate to demonstrate completion of the pattern.

Rider may dismount and drop the bridle to the designated judge.

Judges: Sylvia Jaeckle (Germany), Leo W. Fourre (USA)



"QUARTER HORSE SHOW OF THE YEAR"

Show A: 04 & 05 November 2010 - Show B: 06 & 07 November 2010
New Azelhof – Aarschotsesteenweg 201 – 2500 Lier – Belgium

Patterns Show A

Western Riding (Pattern number 4)

(Amateur / Youth)

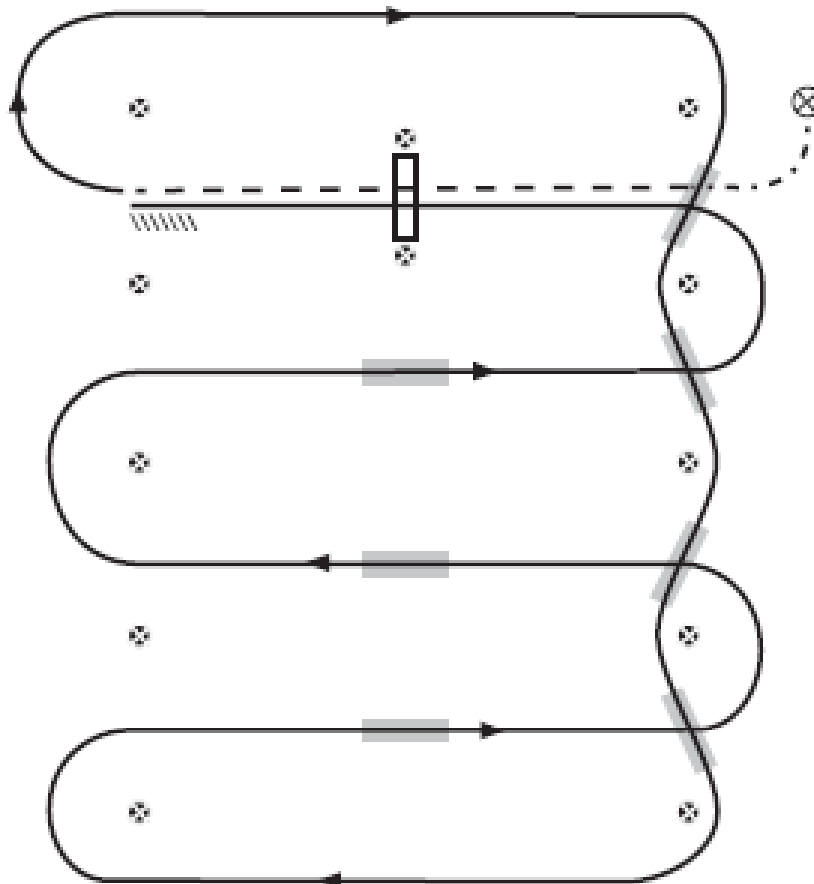

1. Walk, transition to jog, jog over log
2. Transition to the lope, on the right lead
3. First line change
4. Second line change
5. Third line change
6. Fourth line change
7. First crossing change
8. Second crossing change
9. Third crossing change
10. Lope over log
11. Lope, Stop & back

Judges: Sylvia Jaeckle (Germany), Leo W. Fourre (USA)



"QUARTER HORSE SHOW OF THE YEAR"

Show A: 04 & 05 November 2010 - Show B: 06 & 07 November 2010
New Azelhof – Aarschotsesteenweg 201 – 2500 Lier – Belgium

Patterns Show A

Western Riding (Pattern number 2) (Open)

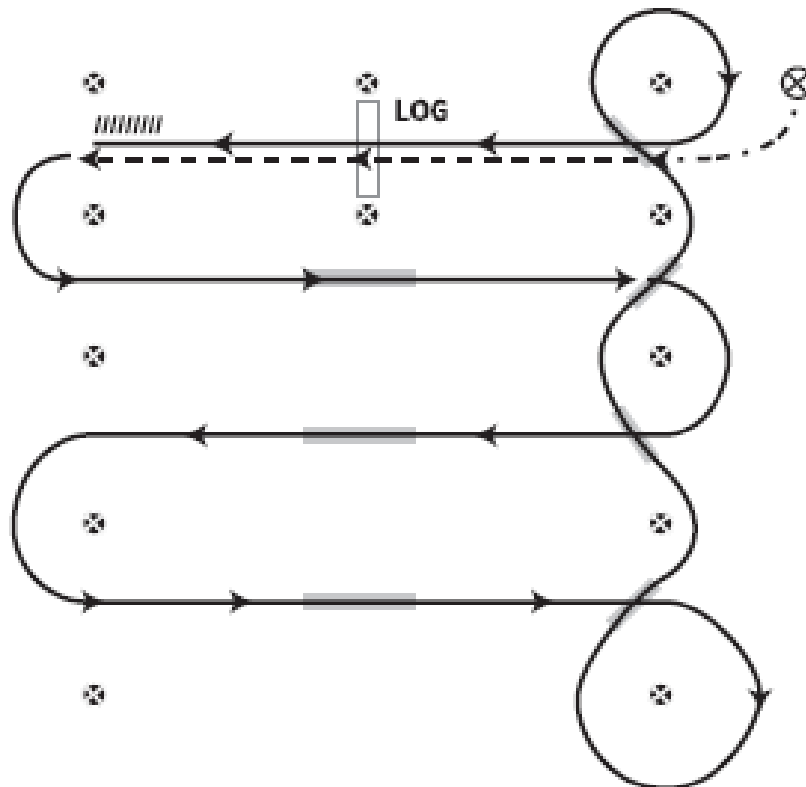

⊗ START GONE WALK - - - - - JOG - - - - -
LEAD CHANGING AREA LOPE - - - - -

1. Walk, transition to jog, jog over log
2. Transition to the lope, on the left lead
3. First crossing change
4. Second crossing change
5. Third crossing change
6. Circle & first line change
7. Second line change
8. Third line change
9. Fourth line change & circle
10. Lope over log
11. Lope, stop & back

Judges: Sylvia Jaeckle (Germany), Leo W. Fourre (USA)